

# PODMIC

DYNAMIC PODCASTING MICROPHONE



The PodMic is a broadcast quality, dynamic microphone optimised for podcasting. It has a rich, balanced sound, with an internal pop filter to minimise plosives and internal shockmounting to reduce vibration.

The PodMic is optimised for use with the RØDECaster™ Pro integrated podcast production console, but will also offer exceptional results with any high-quality microphone interface.

- Broadcast quality dynamic capsule
- Optimised for speech applications
- Internal pop filter to minimise plosives
- Robust, all metal construction
- Optimised for use with RØDECaster Pro console

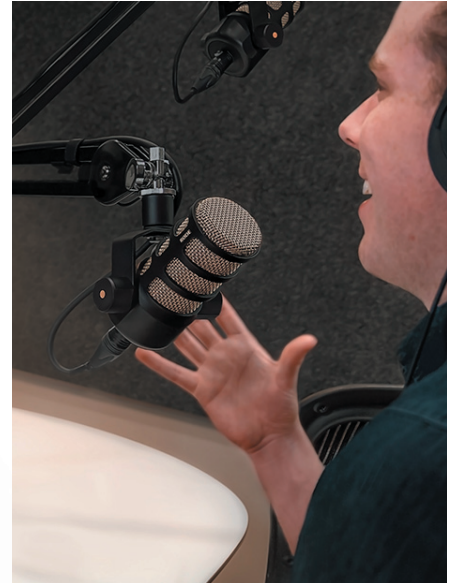

## SPECIFICATIONS

Acoustic Principle:	Dynamic
Polar Pattern:	Cardioid
Frequency Range:	50Hz ~13 kHz
Output Impedance:	320Ω
Sensitivity:	-57.0dB re 1 Volt/Pascal (1.60mV @ 94 dB SPL) +/- 2 dB @ 1kHz
Output Connection:	XLR
Phantom Power:	Not required
Colour:	Black
Weight:	937g
Product Dimensions (LxWxH, mm):	172 x 109 x 62
Compatible RØDE Accessories:	PSA1

Front view

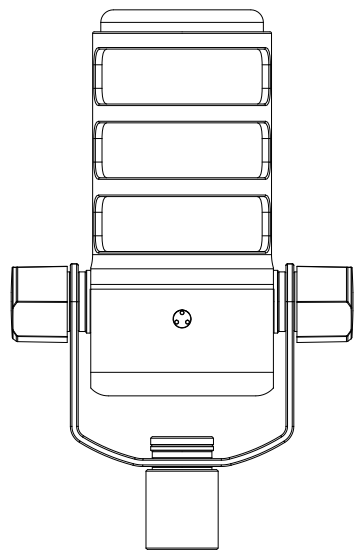

109mm

Side view

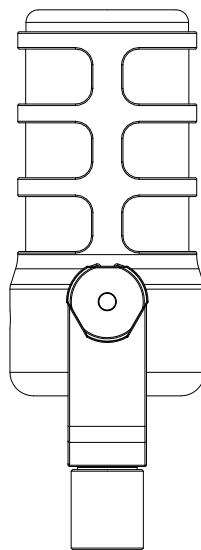

62mm

172mm

